

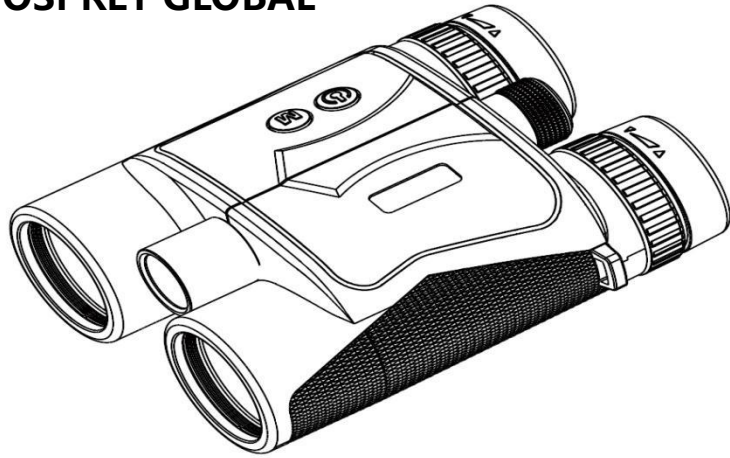

OSPREY GLOBAL



Laser Rangefinder Operating Instructions

Laser Rangefinder Operating Instructions

Operating Instructions1-16



I . CONSTRUCTION

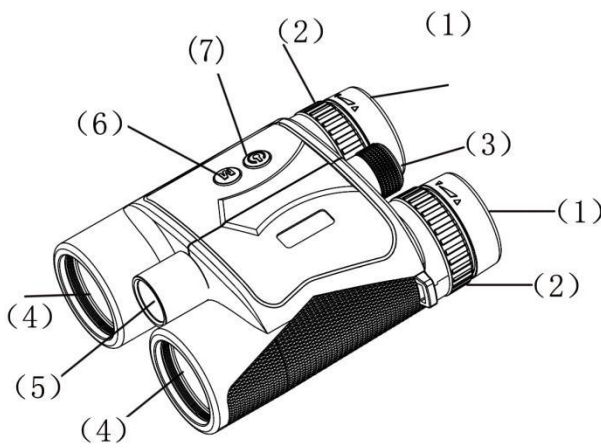

- (1) EYEPIECE
- (2) FOCUSING WHEEL
- (3) BATTERY COVER
- (4) OBJECTIVE LENS
- (5) LASER EMISSION LENS
- (6) **M** MODE KEY
- (7)  POWER KEY

II. BRIEF INTRODUCTION

The device is a high-tech portable machine, combining the functions of a binocular and laser range finder. It changes the distance measure and improves the efficiency.

- The device can measure the distance and speed while showing a clear image, and has advances such as high precision, short ranging time, visual display, low consumption and auto power-off.
- The device is safe to the eyes and body by using 905nm laser and multi coated lens.
- Before operation, please turn the body until the image through the two eyepieces focus on one object. And then adjust the eyepieces until the image is clear. If you wear glasses, please remove the glasses or adjust the eyepiece cups.

III. TECHNOLOGY DATA

MODEL	OBJECTIVE DIAMETER	EXIT PUPIL DIAMETER	MAGNIFICATION	VIEW ANGLE	PRECISION	MEASUREMENT	SPEED FIELD
10x42LRF	42mm	21.5mm	10X	5°	+/-1M	5~1000M	0~300KM

MODEL	TYPE	WATERPROOF	DIMENSION	WEIGHT	BATTERY	WORKING ENVIRONMENT	AUTOPOWER -OFF
10x42LRF	LASER RANGING	IPx6	155mm*130mm *62mm	950g	3V (CR2)	-10° ~50°	20S AFTER NO OPERATIONS

IV. SCREEN

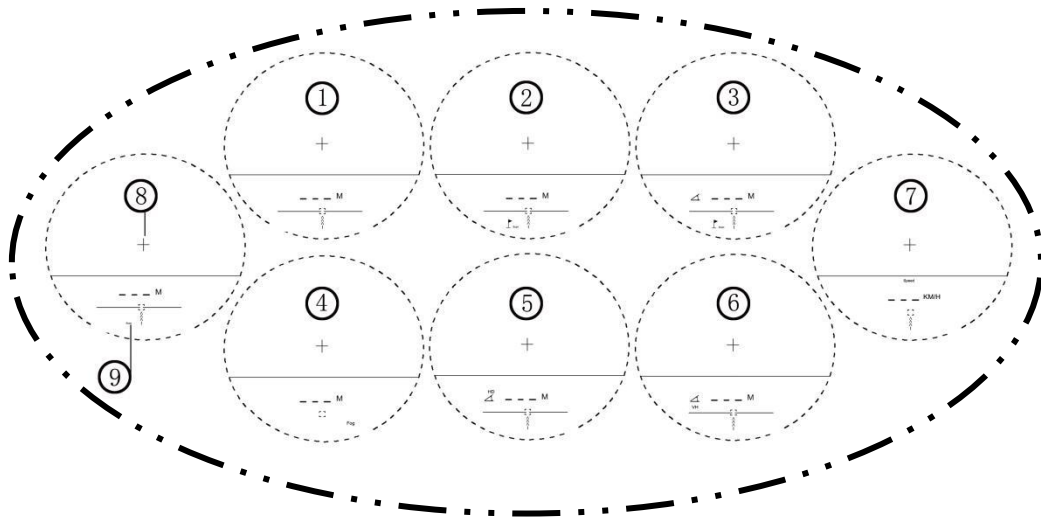

① RANGING

④ FOG

⑦ SPEED

② FLAGPOLELOCK

⑤ ALTITUDE RANGING

⑧ FOCUS

③ ANGLE

⑥ DISTANCE RANGING

⑨ SCAN

V. Operating Instructions

5.1 The Boot Screen

Press  to turn on the rangefinder. The default mode is “ranging” (Picture 1);

5.2 The Measurement Unit

Hold down **M** to select the unit of distance, meter or yards. (picture 2)

After selecting the mode “Ranging”, “Scanning”, “Flagpole Lock”, “Fog”, “Angle”, “Altitude difference”, “Distance difference” hold down **M** to select the measuring unit, no need to change the unit again when exchanging within these seven modes.

The measurement unit would be selected again separately in the “Speed” mode.

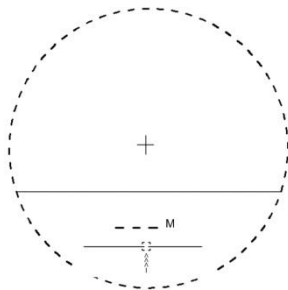

Picture 1

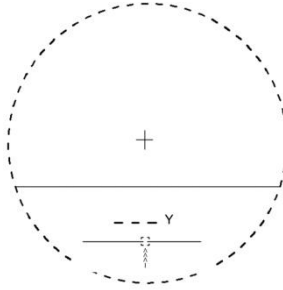

Picture 2

V . Operating Instructions

5.3 Low Battery

A “low battery” symbol will appear when the battery voltage is low (Picture 3).
The rangefinder will soon need battery replacement.

5.4 Mode Selection

Short press **M** to select the modes.

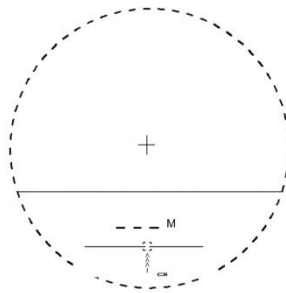

Picture 3

V. Operating Instructions

5.4.1 Ranging

Principle (picture 4)

Ranging screen (picture 5)

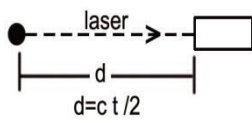

Picture 4

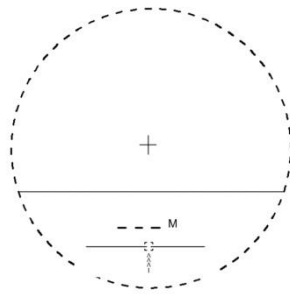

Picture 5

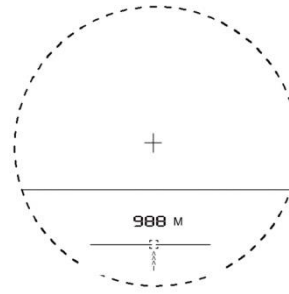

Picture 6

Short press  to start ranging (picture 6).

V. Operating Instructions

5.4.2 Flagpole lock

Principle (picture 7); In this mode, the point D may be isolated from several points in the background, while keeping only the distance d_1 to the point, to achieve the automatic locking flagpole distance. The other goals are shielded behind the flagpole.

Screen (picture 8).

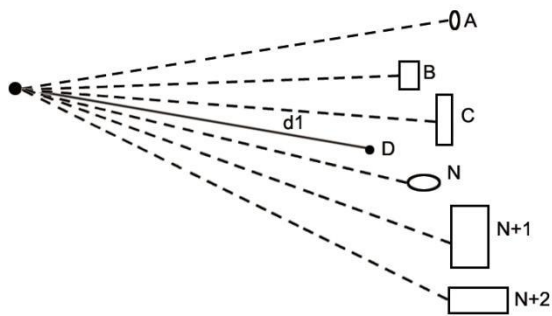

picture 7

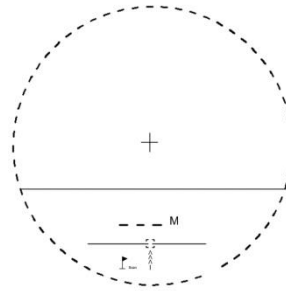

picture 8

V. Operating Instructions

After choosing the flagpole lock mode, aim the device at the flagpole, ensuring the pole is in the center on the screen and press  to start scanning. A box will appear in the center of the screen. When the box begins to flash a second box will appear around the flag symbol. After the flash, the data is locked. (picture 9).

5. 4. 3 Fog

Principle (picture 10)

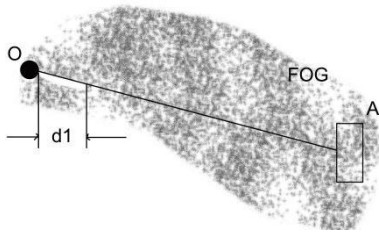

picture 10

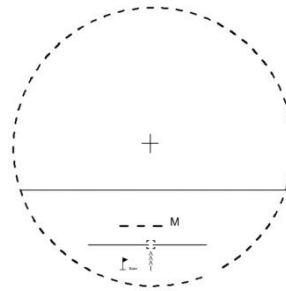

picture 9

V. Operating Instructions

The micro particles in the fog will reflect the riser, making it unable to measure the distant targets. To ensure the precision, the rangefinder will handle the interference caused by the micro particles in the close distance ($d_1=25m$). (picture 11)

Press the mode button **M** until the “Fog” mode screen appears. Short press  to start ranging. Fog screen (picture 12)

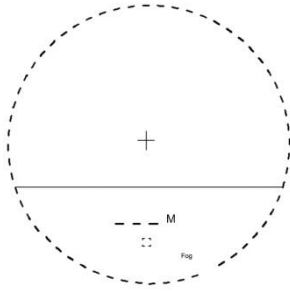

picture 11

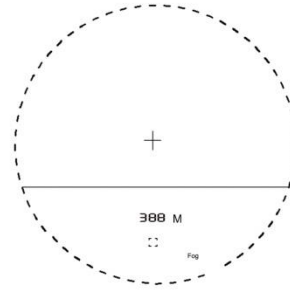

picture 12

V. Operating Instructions

5.4.4 “Angle”, “Altitude ranging”, “Distance ranging”

Principle (picture 13)

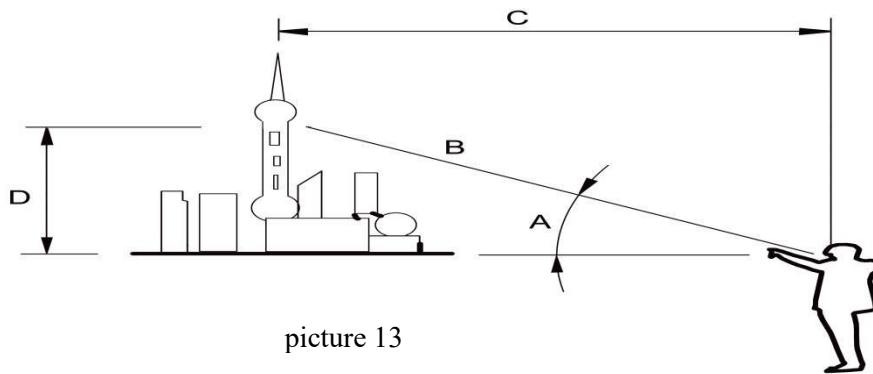

picture 13

A. Angle B. Ranging C. Distance ranging D. Altitude ranging

V. Operating Instructions

Press the mode button **M** to choose the mode. Short press  to start ranging.
Ranging screen (picture 14, 15, 16)

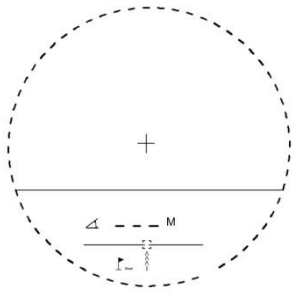

picture 14

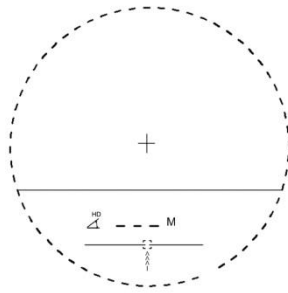

picture 15

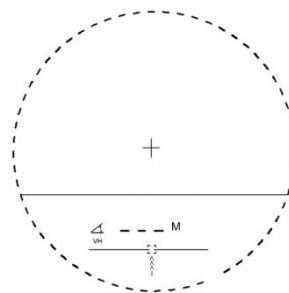

picture 16

V. Operating Instructions

5. 4. 5 Speed

Principle (picture 17). Measure the target twice and get the speed by dividing the time and distance. (picture 18). Speed screen (picture 19)

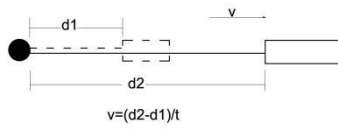

picture 17

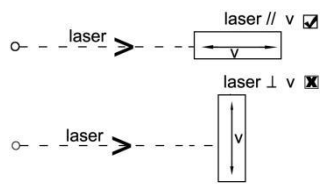

picture 18

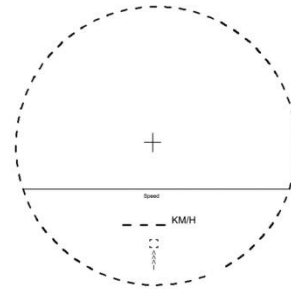

picture 19

V. Operating Instructions

Press the mode button until the “Speed” mode screen appears. Hold down the mode button **M** to select the unit of measurement. Short press **⏻** to measure the speed. Kilometers per hour (KM/H) (picture 20). Miles per hour (M/H) (picture 21).

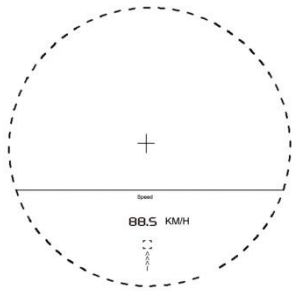

picture20

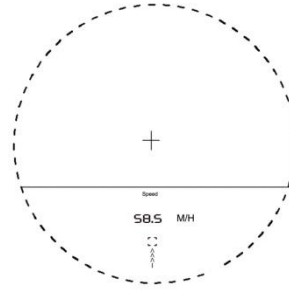

picture21

V. Operating Instructions

5.4.6 scan

Press the mode button **M** until the “Scan” mode screen appears. Short press  to measure the scan. Scan screen (picture 22)

The laser will run continuously and all targets will show on the screen one by one (picture 23). The screen will automatically exit after 20 consecutive points are measured.

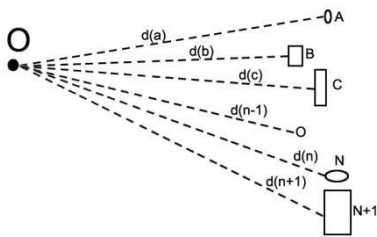

picture 22

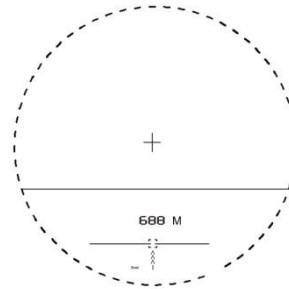

picture 23

VI.CAUTIONS

- The measurement range will be affected by the nature of object, beam launch, angle with the target surface and the weather, etc.
- When the low battery indicator is displayed, the battery should be replaced. Otherwise, the error will increase. When the device will not be used for a long time, please remove the battery from the device.
- Please do not look through the laser emission lens and objective lens when pressing  , it may cause damage to your eyes.
- Please use lens cleaning cloth to wipe the dirt gently. Using other objects may damage the coating on the lens.
- Please store in a dry and cool location. Avoid direct sunlight and dust.
- Please ask for help from a technician if the device is damaged. Do not disassemble by yourself.